



Ventvisor® Deflector

For proper installation and best possible fit, please read all instructions BEFORE you begin. For technical assistance or to obtain missing parts, please call Customer Relations at 1-800-241-7219.

Important Safety Information



- CAUTION - Before driving, ensure that the vent visor is properly secured to vehicle.
- Do not use automatic "brush-style" car washes.
- Do not use cleaning solvents of any kind.
- Periodically check all components for tightness.

Contents - 2 Piece Set **NOTE:** Actual product may vary from illustration.



Front Driver Side Visor



Front Passenger Side Visor



Alcohol Pad x2

Contents - 4 Piece Set



Front Driver Side Visor



Front Passenger Side Visor



Rear Driver Side Visor



Rear Passenger Side Visor



Alcohol Pad x4

Tools Required



Car Wash Supplies

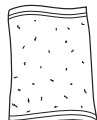

Clean Towel

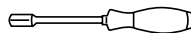

Nut Driver

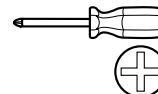

Phillips Screwdriver

Preparation Before Painting / Installation

- A trial fit is recommended to ensure proper positioning and fit.
- Check fit of parts before painting as we will not accept the return of modified or painted parts.
- Wash and dry your vehicle to remove any debris and/or dirt from the installation area.

Installation Steps **NOTE:** Actual application may vary slightly from illustrations.



Clean the metal door frame around the window with an alcohol pad.

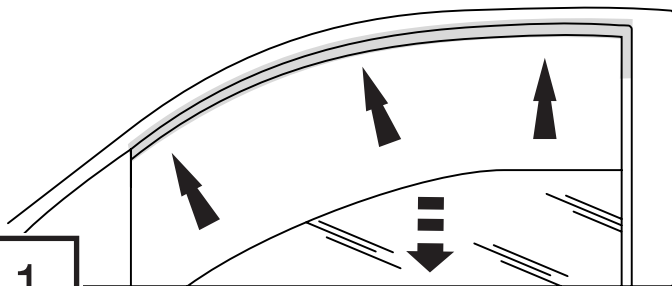

1

Remove tape liner from rear flange. Peel back 2" (5 cm) of tape line from each end of top flange.

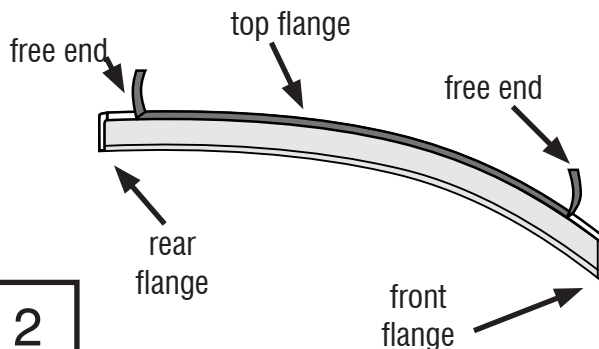

2

Installation Steps

NOTE: Actual application may vary slightly from illustrations.

Remove the triangular plastic mirror cap cover on the inside door panel.

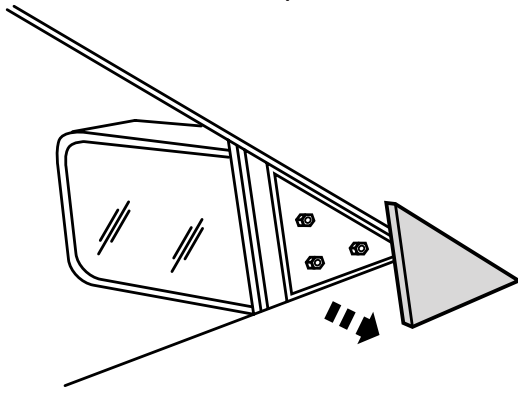

3

Using the appropriate tool, loosen but do not remove the mirror mounting bolts to create a gap behind the mirror cap in order to install the front flange of the deflector.

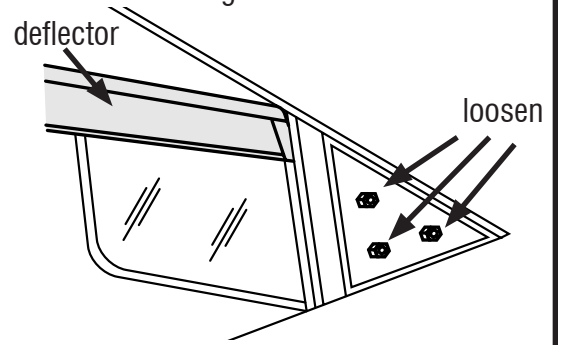
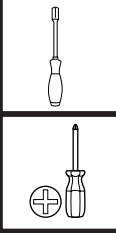

4

Position the deflector on the metal door frame and gently press exposed tape to secure in place.

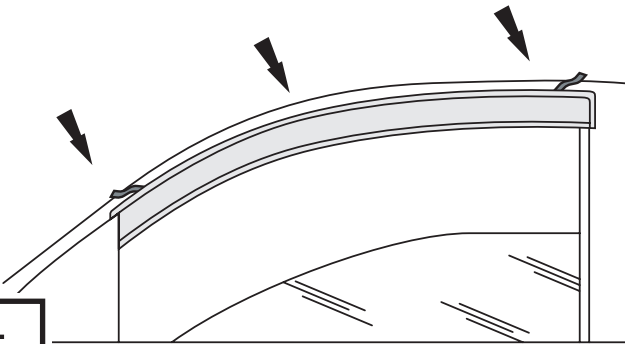

5

With the deflector in its final position, remove remaining tape liner by pulling on free ends.

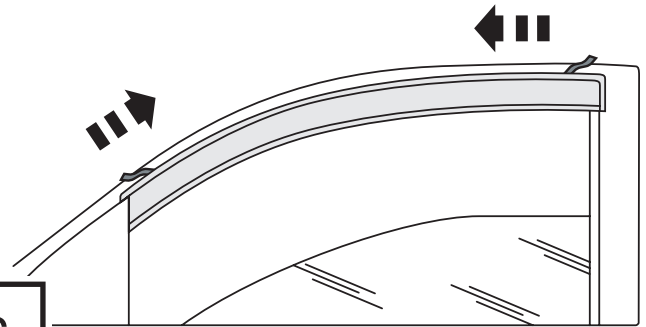

6

Apply pressure along the flange edges to secure in place.

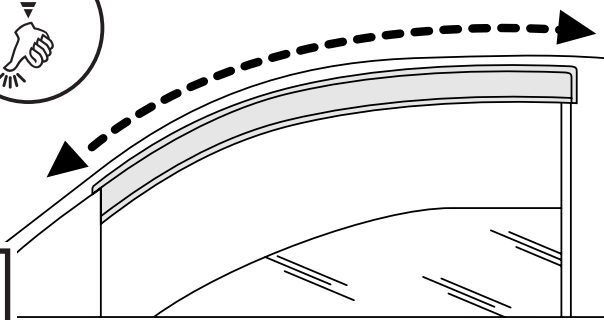

7

Retighten mirror mounting bolts and replace the plastic mirror cap on the inside of door.

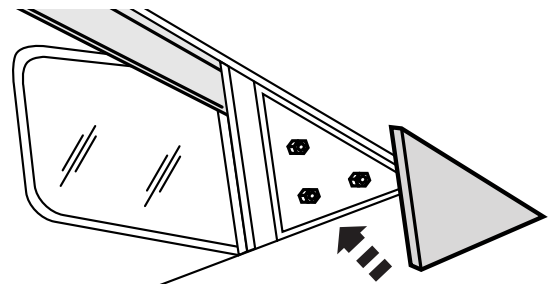
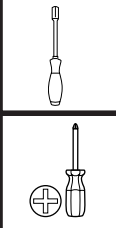

8

To avoid damaging the deflector, **do not over-tighten the mirror mounting bolts.**

Repeat **Steps 1 - 8** for the passenger side front deflector.

Installation Steps

NOTE: Actual application may vary slightly from illustrations.

4 Piece Set

After cleaning with an alcohol pad and peeling back tape liner, repeat **Steps 5 - 7** for the rear deflectors.

Alcohol
Pad

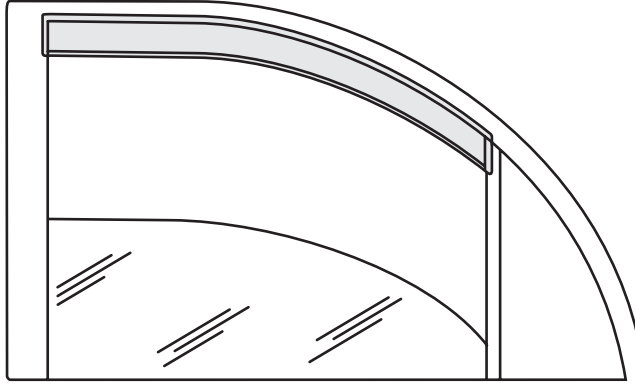

9

Care and Cleaning

- Wash only with mild soap & dry with a clean cloth.

Congratulations!

You have purchased one of the many quality Auto Ventshade™ branded products offered by Lund International, Inc. We take the utmost pride in our products and want you to enjoy years of satisfaction from your investment. We have made every effort to ensure that your product is top quality in terms of fit, durability, finish and ease of installation.



Lund International

800-241-7219 • Visit us at lundinternational.com

© 2012 Lund International, Inc. All rights reserved.

Auto Ventshade™, the Auto Ventshade™ logo and the AVS™ logo are trademarks of Lund International, Inc.





Ventvisor® Deflector

Pour obtenir une installation correcte et le meilleur ajustement possible, lire toutes les instructions AVANT de commencer.
 Pour toute assistance technique ou obtention de pièces manquantes, appeler le service des relations avec la clientèle au 1-800-241-7219.

Informations importantes concernant la sécurité



- ATTENTION – Avant de conduire, s'assurer que la visière est solidement assujettie sur le véhicule.
- Ne pas utiliser les stations de lavage de voitures à brosses.
- Ne pas utiliser de solvants.
- Vérifier régulièrement le serrage des composants.

Contenu - Ensemble 2 pièces

NOTE: Le produit réel peut changer de l'illustration.

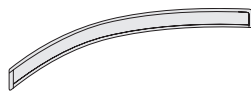

Visière avant côté conducteur



Visière avant côté passager



Tampons à l'alcool (2)

Contenu - Ensemble 4 pièces



Visière avant côté conducteur



Visière avant côté passager



Visière arrière côté conducteur



Visière arrière côté passager



Tampons à l'alcool (4)

Outils nécessaires



Fournitures pour lavage de voiture



Serviette propre

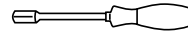

Clé à douille

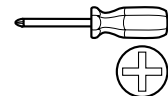

Tournevis Phillips

Préparation pour la peinture/l'installation

- Il est recommandé de procéder à un essai pour s'assurer que le positionnement et l'ajustement sont corrects.
- Vérifier l'ajustement des pièces avant peinture, car nous n'acceptons pas le retour de pièces modifiées ou peintes.
- Laver les glissières de glaces de la portière du véhicule pour éliminer toute poussière et tous débris.
- Sécher les glissières avec une serviette propre.

Étapes d'installation

REMARQUE : La méthode d'application peut être légèrement différente de celle représentée par les illustrations.

Alcohol Pad

Nettoyer avec un tampon à l'alcool l'encadrement métallique de la portière autour de la glace.

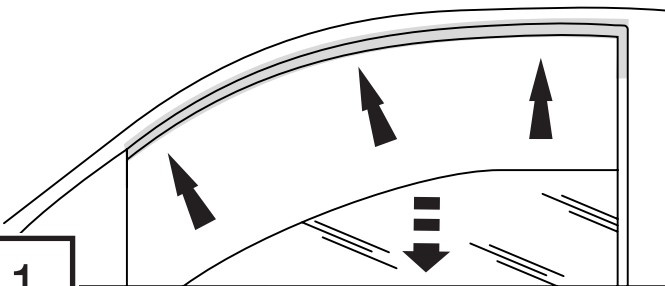

1

Retirer la protection d'adhésif du rebord arrière. Décoller environ 5 cm (2 po) de protection d'adhésif à chaque extrémité du rebord supérieur.

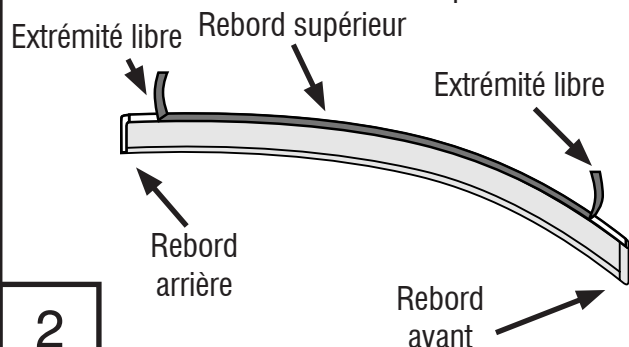

2

Étapes d'installation

REMARQUE : La méthode d'application peut être légèrement différente de celle représentée par les illustrations.

Retirer le couvercle triangulaire en plastique du rétroviseur, sur le panneau intérieur de la portière.

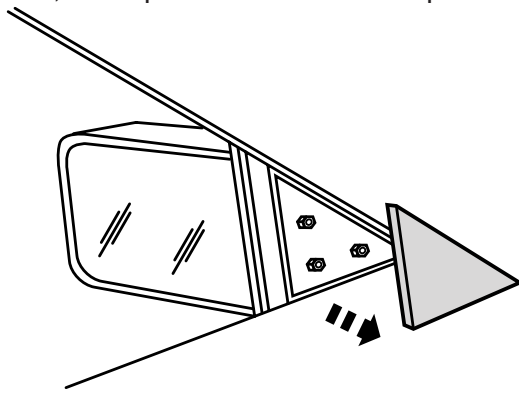

3

En utilisant l'outil approprié, détachez mais n'enlevez pas les boulons de fixation de miroir pour créer un espace derrière le chapeau de miroir afin d'installer la bride avant du déflecteur.

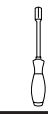

Déflecteur

4

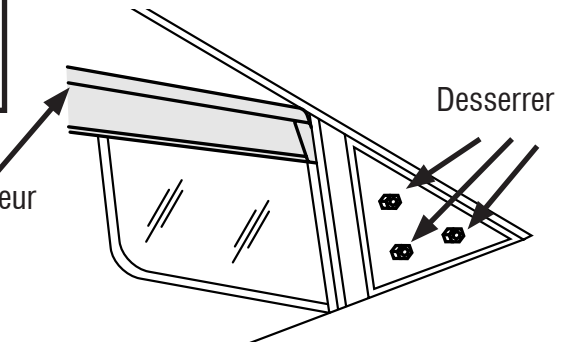

Positionner le déflecteur sur l'encadrement métallique de la portière, et appuyer avec précaution sur la partie exposée du ruban adhésif pour bien le fixer en place.

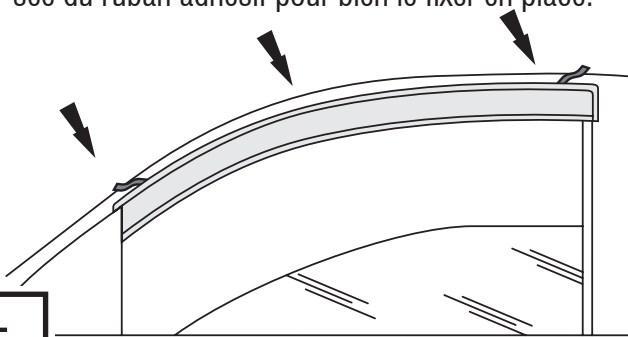

5

Une fois le déflecteur en position finale, retirer le reste de la protection d'adhésif en tirant sur les extrémités libres.

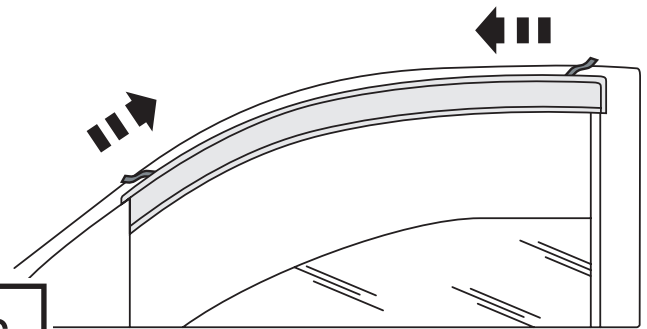

6

Appuyer tout le long des rebords pour bien fixer le tout en place.

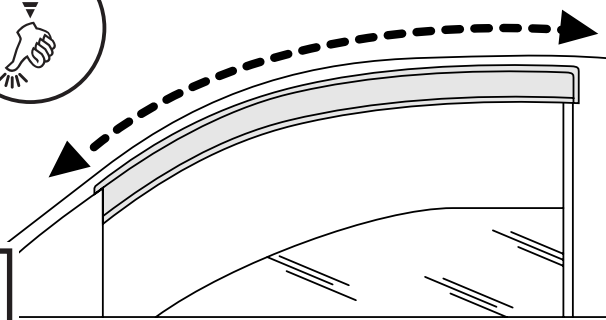

7



Resserrer les boulons de montage du rétroviseur et remettre en place le couvercle du rétroviseur, à l'intérieur de la portière.

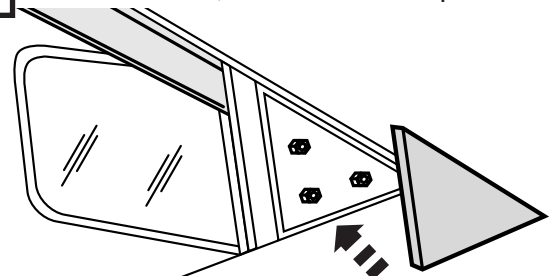

8

Pour éviter d'endommager le déflecteur, **ne pas trop serrer les boulons de montage du rétroviseur.**

Répéter les **étapes 1 à 8** pour le déflecteur avant du côté passager.

Étapes d'installation Ensemble 4 pièces

REMARQUE : La méthode d'application peut être légèrement différente de celle représentée par les illustrations.

Après avoir nettoyé à l'aide d'un tampon à l'alcool et avoir décollé la protection d'adhésif, répéter les **étapes 5 à 7** pour les déflecteurs arrière.

Alcohol
Pad

9

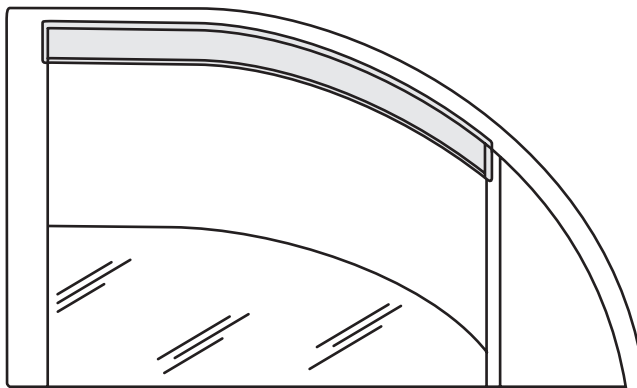

Entretien et nettoyage

- Laver exclusivement avec de l'eau savonneuse et sécher avec un chiffon propre.

Félicitations !

Vous avez acheté l'un des nombreux produits de qualité Auto Ventshade™ fabriqués par Lund International, Inc. Nous sommes extrêmement fiers de nos produits et souhaitons que vous tiriez des années de satisfaction de votre investissement. Nous avons pris toutes les mesures nécessaires pour assurer que ce produit est d'une qualité supérieure en ce qui concerne l'ajustement, la durabilité, la finition et la facilité d'installation.



Lund International

800-241-7219 • Visitez notre site lundinternational.com

© 2012 Lund International, Inc. Tous droits réservés.



Auto Ventshade™, le logo Auto Ventshade™ et le logo AVS™ sont des marques déposées de Lund International, Inc.





Ventvisor® Deflector

Para una instalación adecuada y el mejor ajuste posible, lea todas las instrucciones ANTES de comenzar. Si desea recibir asistencia técnica u obtener piezas faltantes, llame al Servicio al cliente al 1-800-241-7219.

Información importante de seguridad



- **PRECAUCIÓN** - Antes de conducir, asegúrese de que la visera esté correctamente anclada al vehículo.
- No utilice servicios automáticos de limpieza de vehículos que utilizan cepillos.
- No utilice limpiadores al solvente de ningún tipo.
- Compruebe periódicamente que todos los componentes estén ajustados.

Contenido - Juego de dos piezas

NOTA: El producto real puede variar de la ilustración.



Visera delantera del conductor



Visera delantera del acompañante



Paños esterilizados x 2

Contenido - Juego de cuatro piezas



Visera delantera del conductor



Visera delantera del acompañante



Visera trasera del conductor



Visera trasera del acompañante



Paños esterilizados x 4

Herramientas necesarias



Equipo de limpieza de vehículos



Toalla limpia

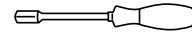

Aprietatuercas

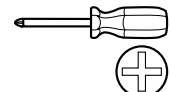

Destornillador Phillips

Preparación antes de pintar o instalar

- Se recomienda realizar un ajuste de prueba para asegurar el posicionamiento y ajuste correctos.
- Compruebe que las piezas se ajusten correctamente antes de pintarlas, ya que no aceptaremos la devolución de piezas modificadas o pintadas.
- Lave los canales de la ventanilla del vehículo para quitar los desechos y la suciedad.
- Seque los canales de la ventanilla con una toalla limpia.

Pasos de instalación

AVISO: La colocación real puede variar con respecto a las ilustraciones.

Alcohol Pad

Limpie el marco de metal de la puerta situado alrededor de la ventana con un paño esterilizado.

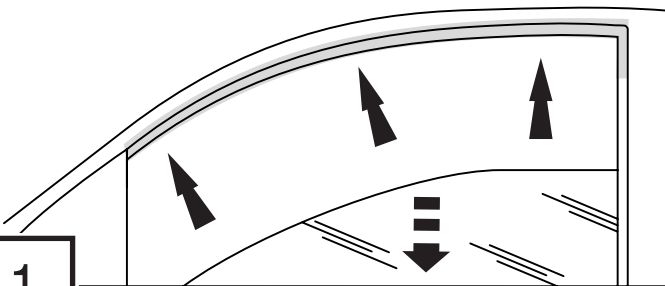

1

Quite la cinta protectora del reborde trasero. Retire 2 pulgs. (5 cm) de cinta protectora de cada uno de los extremos del reborde superior.

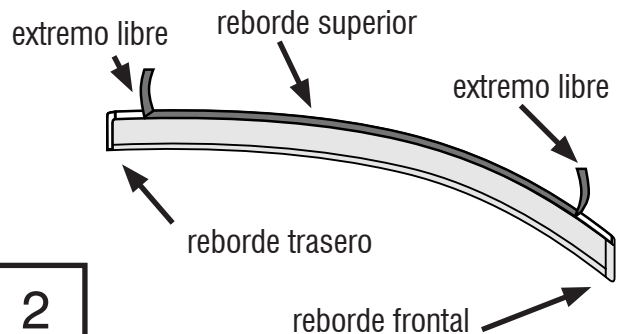

2

Pasos de instalación

AVISO: La colocación real puede variar con respecto a las ilustraciones.

Retire la tapa triangular de la cubierta plástica del espejo situada en el panel interior de la puerta.

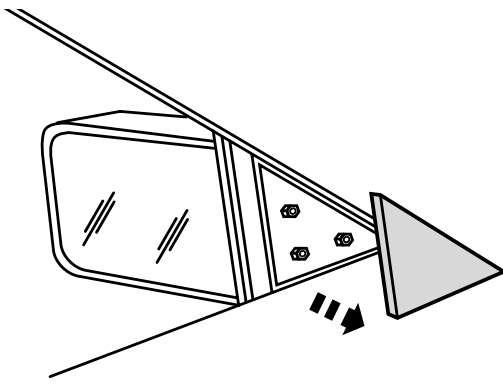

3

Con la herramienta apropiada, afloje pero no quite los pernos de montaje del espejo para crear un boquete detrás del casquillo del espejo para instalar el reborde delantero de la desviación.

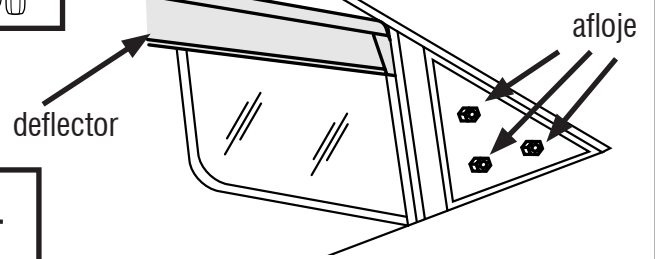
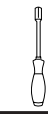

4

Coloque el deflector en el marco de metal de la puerta y presione suavemente la cinta expuesta para fijarlo en su lugar.

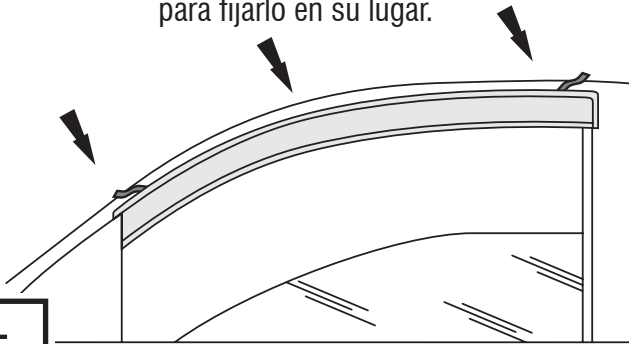

5

Una vez que el deflector se encuentra en su posición definitiva, quite la cinta protectora restante tirando de los extremos que quedaron libres.

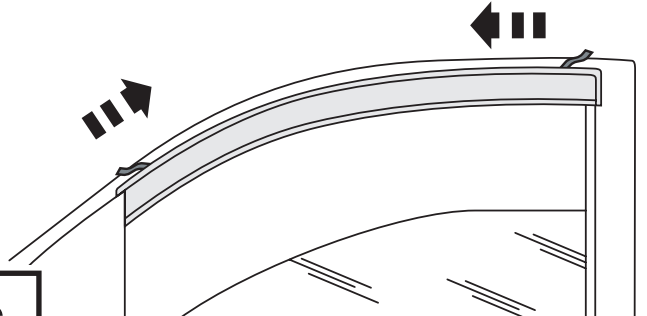

6

Presione sobre los bordes del reborde para fijarlo en su lugar.

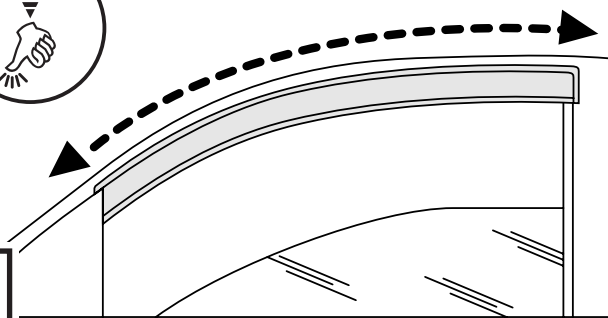

7

Vuelva a ajustar los pernos de montaje del espejo y reemplace la cubierta plástica del espejo situada en la parte interior de la puerta.

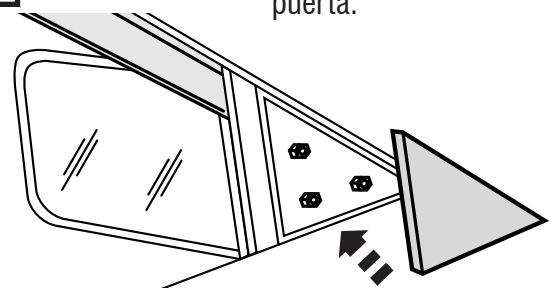

8

Para evitar que se dañe el deflector, **no ajuste demasiado los pernos de montaje del espejo.**

Repita los **Pasos 1 a 8** para el deflector frontal del lado del acompañante.

Pasos de instalación

AVISO: La colocación real puede variar con respecto a las ilustraciones.

Juego de cuatro piezas

Después de limpiarlo con un paño esterilizado y de quitar la cinta protectora, repita los **Pasos 5 a 7** para los deflectores traseros.

Alcohol
Pad

9

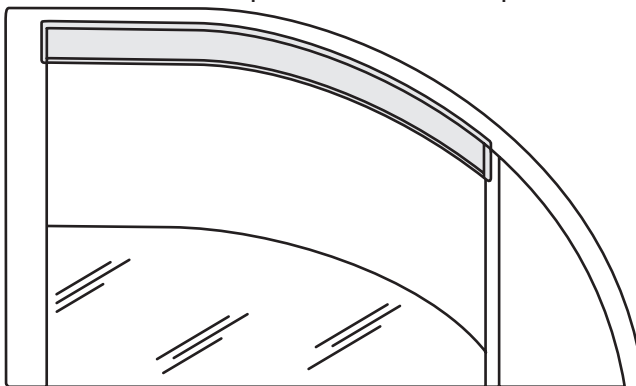

Cuidado y limpieza

- Limpie solamente con agua jabonosa tibia y seque con un paño limpio.

Felicidades

Usted ha comprado uno de los tantos artículos de calidad de Auto Ventshade™ ofrecidos por Lund International, Inc. Nuestros productos son nuestro mayor orgullo. Deseamos que disfrute de años de satisfacción con su inversión. Hemos realizado todos los esfuerzos para asegurarnos de que su producto sea de la mejor calidad en cuanto a ajuste, durabilidad, acabado y facilidad de instalación.



Lund International

800-241-7219 • Visite nuestro sitio Web: lundinternational.com

© 2012 Lund International, Inc. Todos los derechos reservados.



Auto Ventshade™, el logo de Auto Ventshade™ y el logo de AVS™ son marcas comerciales de Lund International, Inc.

